

TECHNICAL DOCUMENTATION OPERATION



Mobile DC Fast-Charger

MDC44-17-2.0

Translation of the original manual

Designwerk GmbH, Lagerplatz 27, CH-8400 Winterthur
T +41 44 515 48 58 info@design-werk.ch

Document name Technical documentation. Operation of the Mobile DC Fast-Charger			
Author V. Dettwiler, Designwerk GmbH	Revision 2.0		

Publishers Imprint

Publisher	Designwerk GmbH, Lagerplatz 27, CH-8400 Winterthur T +41 44 515 48 58 info@design-werk.ch
Issue Date	12.03.16
Copyright	© 2016 The content of this document must not be shared with third parties – either wholly or in part – without the prior written permission of Designwerk GmbH. All technical details, drawings and photos provided are copyrighted. Violations will be prosecuted.
Updates	As the technology in our products is continually updated, we reserve the right to make technical changes to the product's design and construction. Notification of any changes to the individual manuals will be provided in the form of an exchange of the affected pages or an update of the electronic data carrier.
Produced by /author	V. O. Dettwiler

Document revisions

Version	Date	Author	Changes / Comments
0.5	04.02.16	VDR	Document created
1.0	12.03.16	VDR	Amendments to HMI
2.0	29.06.17	VDR	Changes to device version 2.0

Validity

This manual is intended solely for the devices listed in the following table:

Typ	Code 1	Code 2
MDC44	16	1
MDC44	17	2



Document name Technical documentation. Operation of the Mobile DC Fast-Charger			
Author V. Dettwiler, Designwerk GmbH	Revision 2.0	Date 29. June 2017	Page 2 / 28

Table of contents

1	Foreword.....	4
2	Safety and warning symbols.....	4
2.1	Symbols and their meaning.....	4
2.2	Safety symbols and instructions, and risk levels.....	6
2.3	General safety instructions.....	7
2.4	Safety features / Power limitations.....	9
2.5	Requirements on the user.....	10
3	General information.....	11
3.1	Scope of this manual.....	11
3.2	Scope of overall documentation.....	11
3.3	Scope of delivery.....	12
3.4	Optional scope of delivery.....	12
3.5	Manufacturer's contact details.....	13
3.6	Standards used.....	13
3.7	EU declaration of conformity.....	14
4	Use and limitations of the product.....	15
4.1	Intended use.....	15
4.2	Improper use / product limitations.....	15
5	About this device.....	16
5.1	Technical specifications.....	16
5.2	Warning symbols on the device.....	18
5.3	Technical features.....	19
5.4	Basic functions.....	19
5.5	Transportation and storage.....	19
5.6	Operating positions.....	19
5.7	Product description.....	20
5.8	Typenschild.....	21
6	Operation.....	22
6.1	Initial state.....	22
6.2	Preparing charger.....	22
6.3	Charging the vehicle.....	23
6.4	Menu structure.....	24
6.5	Ending the charging process.....	25
6.6	Storing the charger after use.....	25
7	Warranty.....	26
7.1	Warranty claims.....	26
7.2	Warranty exclusions.....	26
8	Additional notes.....	26
9	Appendix.....	27
9.1	Error list.....	27

Document name			
Technical documentation. Operation of the Mobile DC Fast-Charger			
Author	Revision	Date	Page
V. Dettwiler, Designwerk GmbH	2.0	29. June 2017	3 / 28

1 Foreword

Dear customer

Thank you for purchasing this device. This mobile DC fast-charger is a high-performance and highly versatile product. As the power electronics in this product involve hazardous voltages and currents, expert knowledge is required to operate this device.



You **MUST** read this manual carefully – especially the section *Safety and warning symbols* – before using this charger or performing any other type of work associated with it.

2 Safety and warning symbols









This section describes the safety signs relevant to this device. These relate to commissioning as well as operation with a vehicle. Read and follow these instructions for your own and other's safety, to avoid injury to life and limb, and to protect the device from damage.



2.1 Symbols and their meaning



Various symbols are used throughout this manual. The following table provides an overview and description of them:

Symbol	Description	Symbol	Description
	Generally prohibited		Attention High Voltage Do not touch
	Do not switch on		

Document name Technical documentation. Operation of the Mobile DC Fast-Charger			
Author V. Dettwiler, Designwerk GmbH	Revision 2.0	Date 29. June 2017	Page 4 / 28

Symbol	Description	Symbol	Description
	General danger warning		Risk of electrical shock
	Risk of an explosion		Battery risk
	Warning: Hot surface		Warning: High voltage
	Warning: High pressure / Risk of unexpected release of fluids		Warning: Fire risk

Symbol	Description	Symbol	Description
	Switch off device		Disconnect from mains

Symbol	Description	Symbol	Description
	Important information on avoiding potential injury/damage		Important information

Document name			
Technical documentation. Operation of the Mobile DC Fast-Charger			
Author	Revision	Date	Page
V. Dettwiler, Designwerk GmbH	2.0	29. June 2017	5 / 28

2.2 Safety symbols and instructions, and risk levels

Danger



This symbol warns of a serious, irreversible risk of injury that may result in death.

Avoid this risk by following these instructions.

Warning



This symbol warns of a serious, yet reversible risk of injury.

Avoid this risk by following these instructions.

Caution



This symbol warns of a minor risk of injury.

Avoid this risk by following these instructions.

Note



This symbol warns of a potential risk of injury or damage if the following instructions and procedures are not followed.

Information



This symbol informs the reader of important information.

Document name

Technical documentation. Operation of the Mobile DC Fast-Charger



Author

V. Dettwiler, Designwerk GmbH

Revision

2.0

Date

29. June 2017

Page

6 / 28

2.3 General safety instructions

2.3.1 Safety instructions relating to cooling water systems

Caution	
	<p>Risk of coolant discharge</p> <p>Before using the device, check the cooling water system is not leaking. If coolant is discharged prior to or during operation, STOP using the device.</p>

2.3.2 Safety instructions relating to mechanical systems

Danger	
	<p>Risk of an explosion - Risk of death</p> <p>DO NOT store flammable materials or combustible liquids near the device. Arcing of the device connectors may ignite these and cause an explosion.</p>

Caution	
	<p>Hot surface and hot exhaust air - Risk of burns</p> <p>The device generates high operating temperatures mainly on the side panels and next to the ventilation grill. Always be careful when touching these areas.</p>

Document name			
Technical documentation. Operation of the Mobile DC Fast-Charger			
Author	Revision	Date	Page
V. Dettwiler, Designwerk GmbH	2.0	29. June 2017	7 / 28

2.3.3 Safety instructions relating to operation

Note

**HV battery damage**

Only use the charger with electric vehicles that are in faultless working order. If the vehicle is reporting a fault prior to connecting the charger, the device **MUST NOT** be used.

Note

**Cable connector damage**

Check the AC and DC cables for faults each time before using the device. Make sure the cables are correctly plugged in and locked into place.

If you use AC or DC cables which were not supplied with the device, check the quality of the cables. **DO NOT** use poor quality cables or ones which are not standards-compliant.

2.3.4 Safety instructions relating to electrical systems

Danger

**High voltage - Risk of death**

If you are unfamiliar with electrical connectors, only use Mode 3 connectors (Type 2 socket) or a specially designed in-cable control box.

In the case of a Mode 1 connector, **NEVER** connect the device to the outlet without a protective earth terminal. Generally you should use a residual current device (RCD) in the power supply line.

Caution

**Risk of cable overheating - Fire risk**

When using a cable reel as an extension to the mains connection, there is a risk it may catch fire owing to heat accumulation. Be sure to unwind the cable fully.

Note



The device **MUST NOT** be opened by an unauthorised person. Opening the device (sealed casing) will void the warranty with Designwerk GmbH.

Document name

Technical documentation. Operation of the Mobile DC Fast-Charger

Author
V. Dettwiler, Designwerk GmbHRevision
2.0Date
29. June 2017Page
8 / 28

2.4 Safety features / Power limitations

2.4.1 Coded CEE Cable

When the optional power cords are used, the unit automatically detects the cable and limits the current to the maximum allowable current. If another cable is used, the device goes into a safety mode and draws only a very limited current. This setting can be changed manually up or down via the menu.

Note	
	<p>Please use only the supplied AC cables. If a standard AC cable is used, it can lead to malfunctions in electrical sockets with electrical interlock.</p> <p>The use of standard CEE extension cables inserted according to the supplied AC cables is allowed.</p>

2.4.2 Mains-Overvoltage protection

The charger features integrated overvoltage protection which permanently protects the device from surge damage. Even minor surges are detected by the fast sensors, causing the device to shut down and restart immediately. High-energy surges (e.g. lightning strikes) are intercepted using surge suppressors.

Overvoltage protection is also integrated into the output side. Thanks to the fast sensors, surges on the HV battery side (e.g. load shedding or fluctuations) are detected, causing the device to shut down and restart immediately.

2.4.3 Main fuse

Each phase (L1, L2, L3, N) in the charger is protected by two 40A fuse to protect the device and the electrical installation from overcurrent damage. If one of these fuses blows, the charger must be returned to Designwerk GmbH.

2.4.4 Overcurrent protection (Derating)

The charger features integrated overcurrent protection which permanently protects the device from overcurrent damage. Overcurrents in the mains network are detected by the fast sensors and, depending on the strength, are either reduced or the device is shut down and restarted immediately. The mains input side of the charger is also equipped with safety devices which additionally allow the device to be switched off immediately in an emergency.

2.4.5 Overload protection (derating)

The device is designed to work up to an external air temperature of +30°C without any loss of charging power (derating). With extreme use or at external air temperatures exceeding +30°C, the device reduces its charging power to protect the charger from damage through overheating. The output is reduced in proportion to the temperature increase until the device temperature falls within the target range again.

Document name			
Technical documentation. Operation of the Mobile DC Fast-Charger			
Author	Revision	Date	Page
V. Dettwiler, Designwerk GmbH	2.0	29. June 2017	9 / 28

2.4.6 Active Discharge

The device's circuits actively discharge. As soon as the device is disconnected from the HV current, the internal HV circuits discharge.

2.5 Requirements on the user

Using a Mode 1 connector (industrial or standard national sockets), the device must only be operated by a qualified electrician or trained individual.

An electrician or trained person includes individuals who:

- are qualified/trained,
- have knowledge and experience of electronics and EVs,
- also have knowledge of the relevant provisions and risks

and who can document this. Furthermore, they must be able to assess the work assigned to them, identify potential risks and decide on the necessary safety measures.

Information



Using industrial or standard country sockets

- Check the cables and plugs for any damage
- Check the mains installation for fuses and an RCD
- Unwind cable reels fully to prevent heat accumulation
- Ensure the plug is inserted fully and correctly
- Avoid connecting cables while under load

Information



Manually reducing the current on the device

All supplied CEE cables are coded to limit the maximum current. If connectors (e.g. construction site power distributors) cannot reliably supply the rated current for one reason or another, the maximum current can be additionally limited on the fast-charger.

Document name

Technical documentation. Operation of the Mobile DC Fast-Charger



Author
V. Dettwiler, Designwerk GmbH

Revision
2.0

Date
29. June 2017

Page
10 / 28

3 General information

3.1 Scope of this manual

This manual offers an overview of all steps needed to install and operate the charger including the necessary safety measures.

Furthermore, it contains technical information, usage information, and a detailed description of the charger and its functions.

The operation and safety information set out in the manual **MUST** be followed precisely to ensure the charger works faultlessly at all times and to satisfy the warranty requirements of Designwerk GmbH.

3.2 Scope of overall documentation

The manual includes the following documents:





- Technical documentation
- EU declaration of conformity
- Operation
- Warranty terms

Document name Technical documentation. Operation of the Mobile DC Fast-Charger			
Author V. Dettwiler, Designwerk GmbH	Revision 2.0	Date 29. June 2017	Page 11 / 28





3.3 Scope of delivery

Description		Article No.	Illustration
1	Fast charger Optional (like on picture): DC Cable AC Cable Castor set	15.0184.101	

3.4 Optional scope of delivery

Description		Article No.	Illustration
1	DC Cable CHAdeMO 125A 4m	15.0184.520	
2	DC Cable CCS Typ2 125A 4m	15.0184.515	
3	DC Cable CCS Typ1 125A 4m	15.0184.510	
4	DC Cable GB/T 125A 4m	15.0184.530	

Document name Technical documentation. Operation of the Mobile DC Fast-Charger			
Author V. Dettwiler, Designwerk GmbH	Revision 2.0	Date 29. June 2017	Page 12 / 28

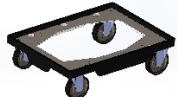
5	DC Cable Typ2 DC-Mid (SC) 125A 4m	15.0184.535	
6	Tesla CHAdeMO Adapter	15.0184.537	
7	AC Cable CEE 32A 5m	15.0184.541	
8	AC Cable CEE 63A 5m	15.0184.540	
9	Castor set	15.0184.200	

3.5 Manufacturer's contact details

Designwerk GmbH
 Lagerplatz 27
 CH-8400 Winterthur
 T +41 44 515 48 58
 info@design-werk.ch

3.6 Standards used

The device was designed on the mains side to be compliant with the Low Voltage Directive 2006/95/EU, and on the HV side to be compliant with DC charging standard IEC 62196-3.

The device has been approved for use in Europe only.

This manual has been produced with the help of and in compliance with the EU Directives, national laws and harmonised standards (EN) that apply to the fast-charger product at the time of production.

Document name Technical documentation. Operation of the Mobile DC Fast-Charger			
Author V. Dettwiler, Designwerk GmbH	Revision 2.0	Date 29. June 2017	Page 13 / 28

3.7 EU declaration of conformity

The manufacturer: Designwerk GmbH
 Lagerplatz 27
 CH-8400 Winterthur
 Switzerland
 Tel: +41 44 515 48 58



hereby declares that the Mobile DC Fast Charger meets the requirements of the following Directives:

2006/42/EG Machinery Directive

2006/95/EG Low Voltage Directive

and complies with the following standards:

IEC 62196-3 DC Charging

EN 60204-1 Safety of machinery

This declaration is rendered invalid if any modifications are made to the product which are not approved by us.

Location:

Date:

Frank Loacker, CTO

Winterthur

12. March 2016

Document name Technical documentation. Operation of the Mobile DC Fast-Charger		 designwerk	
Author V. Dettwiler, Designwerk GmbH	Revision 2.0	Date 29. June 2017	Page 14 / 28

4 Use and limitations of the product

4.1 Intended use

The DC fast-charger is designed to charge a variety of electric and hybrid vehicles which have a DC fast-charging connector. If the device is to be used for any other purpose and you have any questions in relation to this, contact Designwerk GmbH. The user must ensure that the specific operating limits of the connected vehicle and the fast-charger are not exceeded at stage of the charging process.

The device must only be operated within the limits stipulated in the following sub-section.

4.2 Improper use / product limitations

Improper use includes uses other than the operating conditions and requirements stipulated by the manufacturer in its technical documentation and data sheets. The following limits apply to the operation of the fast-charger. Operating the device outside of these limits may damage the device and may lead to life-threatening situations. As such, operating the device in this way is expressly prohibited.

Note



All operating limits in relation to the connected vehicle **MUST** be complied with.

Limit	Value to be complied with	Unit
Single-phase input voltage	360-440	V
Three-phase input voltage	6-63A	A
Single-phase input current	-20 to +70	°C
Three-phase input current	-20 to +40	°C
Ambient storage temperature	3000	m above sea level

Document name

Technical documentation. Operation of the Mobile DC Fast-Charger



Author
V. Dettwiler, Designwerk GmbH

Revision
2.0

Date
29. June 2017

Page
15 / 28

5 About this device

5.1 Technical specifications

AC Input	Value	Unit
Three-phase input voltage	360-440	VAC
Three-phase input current	6-63	A
Input frequency	45-65	Hz
Max. input power	44	kW
Power factor	> 0.99	-
Power factor correction (PFC)	Yes	-
Mains fuse (all phases)	2x40	A
Lightning protection, overvoltage protection IEC	Class 2	-
X capacity	9.4	µF
Y capacity L1 -> PE	40	nF

DC Output	Value	Unit
Reduced power charging voltage range	280-310, 430-450	VDC
Full power charging voltage range	310-430	VDC
Reduced charge current	40	A
Full power charge current	120	A
Reduced power charging capacity	13	kW
Full power charging capacity	42	kW
Power efficiency under 13kW	> 90	%
Power efficiency over 13kW	> 94	%
Max. charge current ripple with max. power	<16	Aeff
Active discharge output capacitor	Yes	-

Document name			
Technical documentation. Operation of the Mobile DC Fast-Charger			
Author	Revision	Date	Page
V. Dettwiler, Designwerk GmbH	2.0	29. June 2017	16 / 28

Thermal / Coolant system	Value	Unit
Coolant volume in device	1.2	L
Coolant mix ratio (glycol / water)	50 / 50 (min -20°C)	%
Ambient storage temperature	-20 to +70	°C
Ambient operating temperature	-20 to +40	°C
Max. device height for usage	3000	m.ü.M
Max. air-flow rate	1200	m ³ /h

Basic mechanical information	Value	Unit
Weight (excl. cable)	47	Kg
Casing material	AlMgSi1 powder coated	-
Casing volume	136.8	L
IP protection class	54	-
Height	500	mm
Width	380	mm
Length	720	mm

Safety and protection functions	Value	Unit
Insulation between mains input and DC output	LV123 / IEC61851	-
Mains input overvoltage protection	264	V
No-load protection	Yes	-
Internal overvoltage protection	Yes	-
Temperature sensor	various	-
Charging cable plug lock	Yes	-
Min. insulating resistance (initial)	>5	MΩ

Document name			
Technical documentation. Operation of the Mobile DC Fast-Charger			
Author	Revision	Date	Page
V. Dettwiler, Designwerk GmbH	2.0	29. June 2017	17 / 28

5.2 Warning symbols on the device

A 'risk of burns' symbol is located on the exhaust-air grill



and a 'high voltage' symbol is located by the DC socket



Document name Technical documentation. Operation of the Mobile DC Fast-Charger			
Author V. Dettwiler, Designwerk GmbH	Revision 2.0	Date 29. June 2017	Page 18 / 28

5.3 Technical features

Besides its considerable 44kW charging capacity, the DC fast-charger is impressively compact and lightweight. This makes the device perfect for mobile and fixed use.

The CEE63 socket on the AC side offers automatic overload protection, allowing operation with a wide variety of mains connectors with a three-phase power output of 11kW to 44kW without any manipulation required on the part of the user at all. Consequently, the charger always uses the maximum power supplied by the mains network.

Thanks to its integrated power factor correction (PFC) and the electroplated separation between the mains supply and HV battery, the device offers maximum power and maximum safety when charging electric and hybrid vehicles.

The low battery power ripple means the device is very battery-friendly even with high charging capacities.

The fast-charger is especially suited to vehicles which have small or very weak onboard chargers.

5.4 Basic functions

The fast-charger charges electric and hybrid vehicles with DC connectors such as CCS Combo Type 2, Type 1 and CHAdeMO connectors.

5.5 Transportation and storage

The charger can be transported flat (on its sides) or upright. Do not transport the device on its top-side (where the carry handle is) or on the front-ends (where the cable connectors are). Make sure the device is secured at all times during transportation to prevent it sliding around.

The best storage position is standing, with the carry handle facing upward.

5.6 Operating positions

The device must be upright, with the carry handle and display facing upward, when being operated.

Note



Keep the front-ends clear of objects so cooling air can circulate freely.

Document name

Technical documentation. Operation of the Mobile DC Fast-Charger



Author
V. Dettwiler, Designwerk GmbH

Revision
2.0

Date
29. June 2017

Page
19 / 28

5.7 Product description

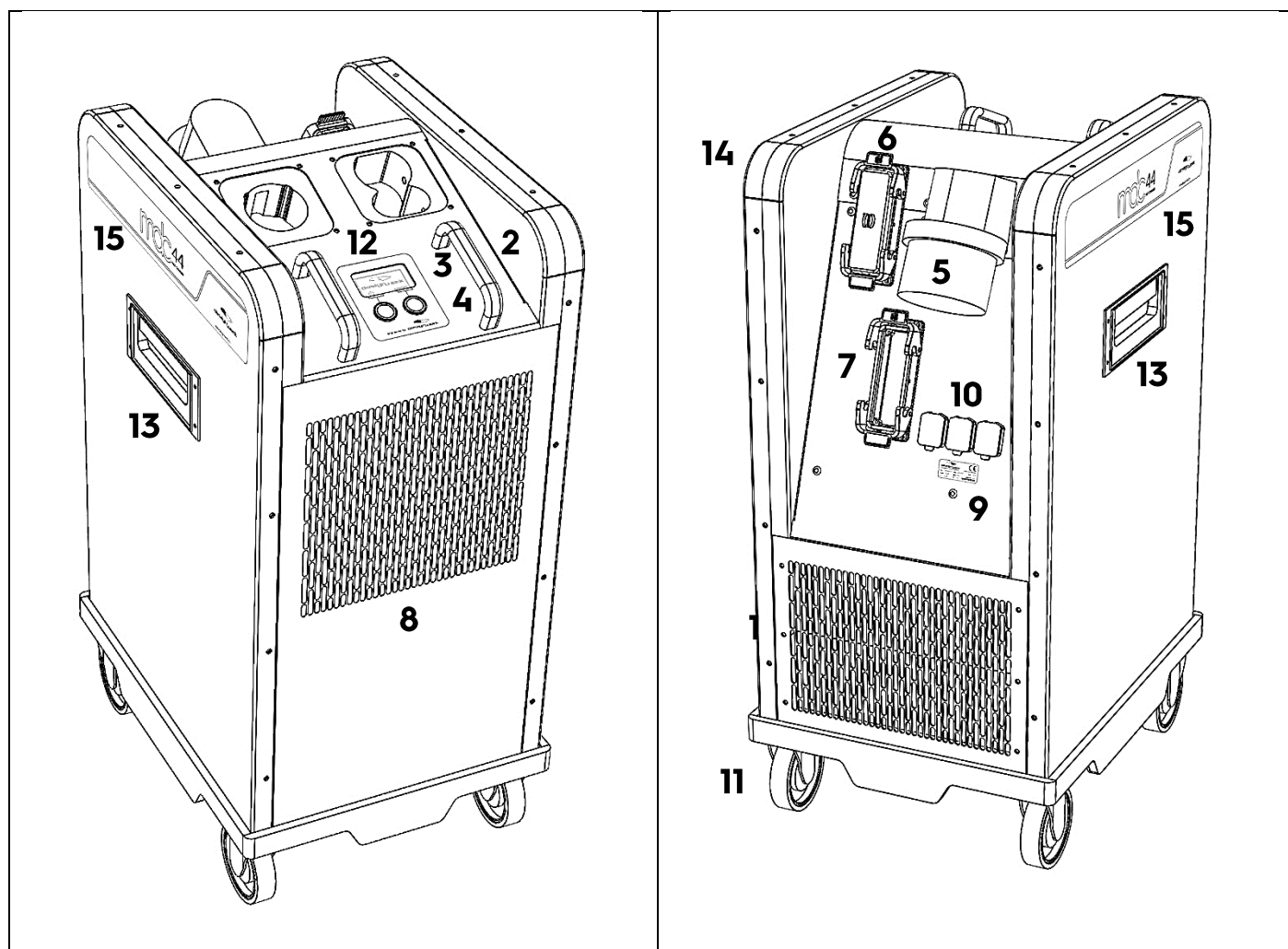

1	Exhaust air port	9	Identification plate
2	Maneuvering handles	10	diagnostic connections
3	Display	11	Castor set
4	Controls	12	DC Vehicle connector parking position
5	Mains connections	13	Carry handle
6	DC Connector	14	Cable reel wings
7	DC Cable parking position	15	Product identification
8	Air intake		

Document name

Technical documentation. Operation of the Mobile DC Fast-Charger



Author
V. Dettwiler, Designwerk GmbH

Revision
2.0

Date
29. June 2017

Page
20 / 28

5.8 Typenschild

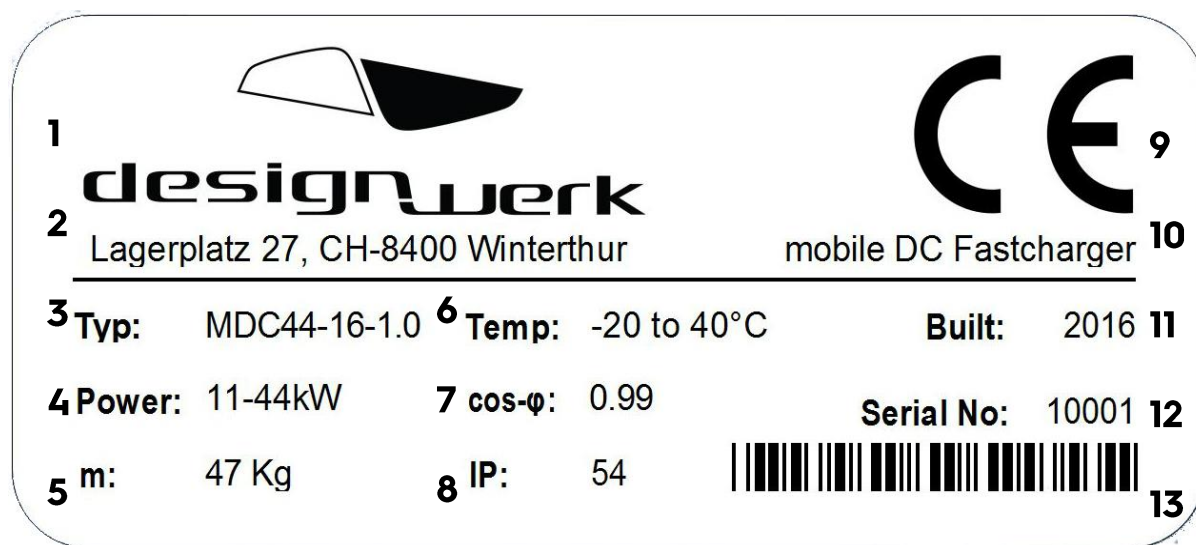

1	Company logo	8	IP protection class
2	Company address	9	CE marking
3	Model name	10	Descriptive model name
4	Input power range	11	Year of construction
5	Device weight	12	Serial number
6	Permitted operating temperature range	13	Barcode
7	Power factor correction (PFC)		

Document name Technical documentation. Operation of the Mobile DC Fast-Charger			
Author V. Dettwiler, Designwerk GmbH	Revision 2.0	Date 29. June 2017	Page 21 / 28

6 Operation

6.1 Initial state

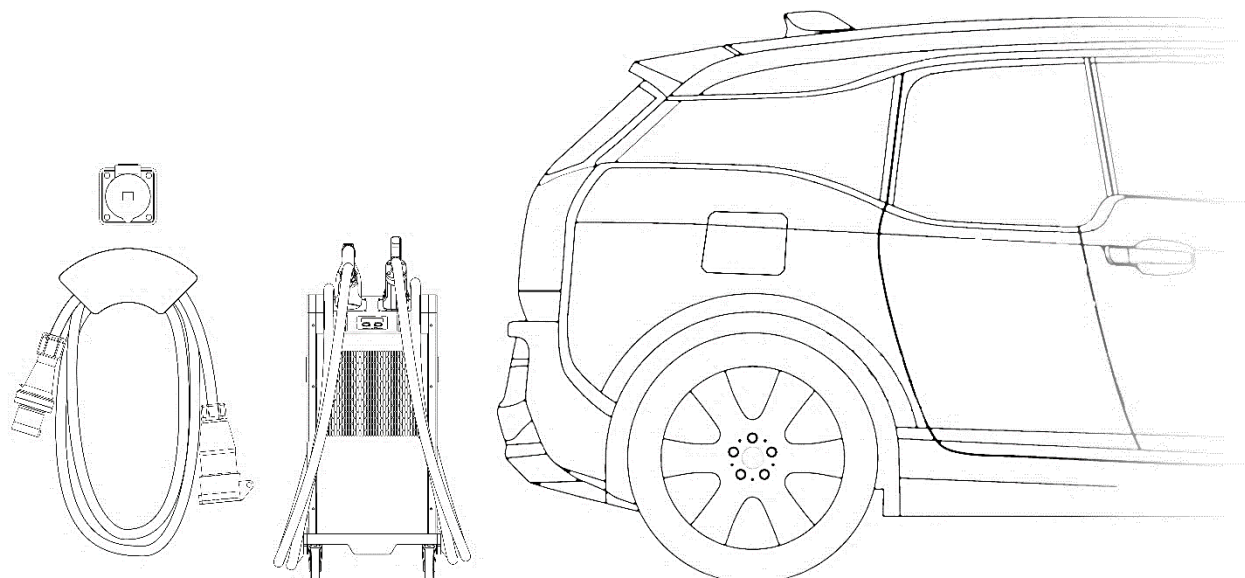

Fast charging requires a powerful mains supply, ideally a CEE 63A/400V industrial socket. Park your vehicle so the fast-charger can be connected to the mains supply using the supplied cables with the cables lying in the floor and not stretched.

6.2 Preparing charger

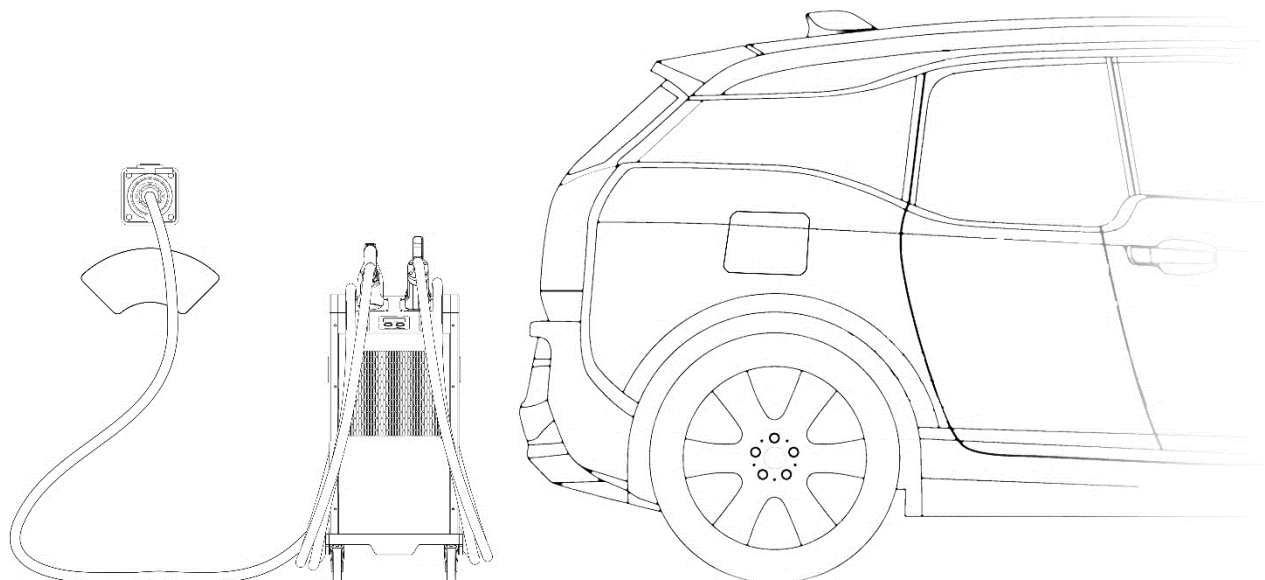

Plug the DC cable and the AC cable into the fast-charger. Now connect the AC cable to the mains supply.

Document name Technical documentation. Operation of the Mobile DC Fast-Charger			
Author V. Dettwiler, Designwerk GmbH	Revision 2.0	Date 29. June 2017	Page 22 / 28

6.3 Charging the vehicle

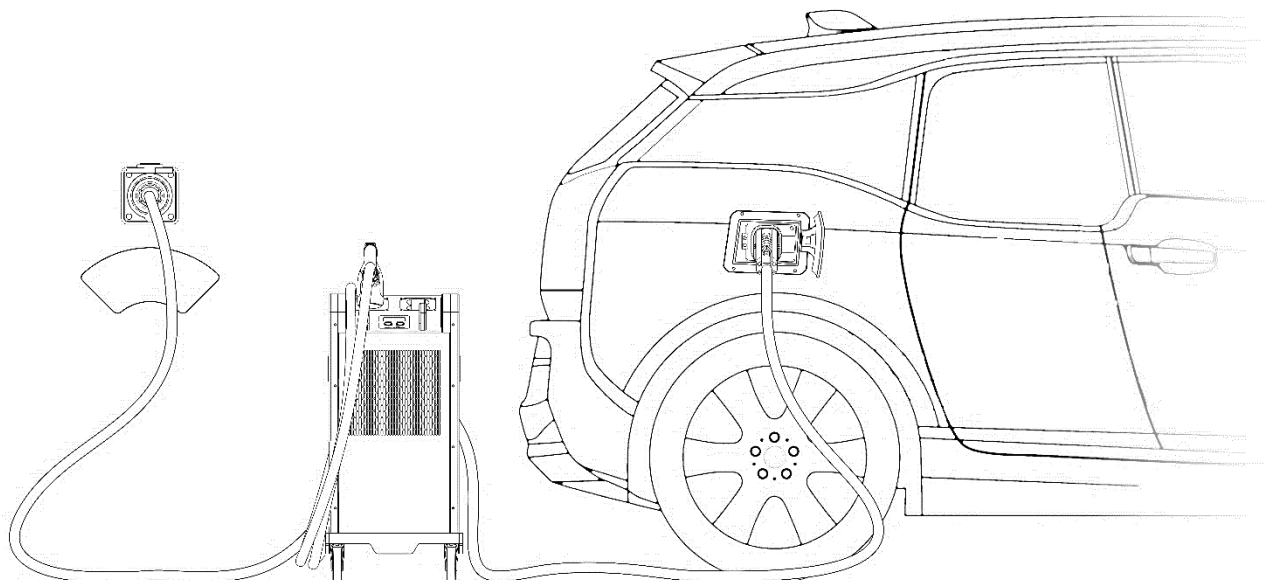

Now connect the DC plug to the vehicle. Depending on the charging procedure, fast-charging will commence automatically or you will need to press the START button on the fast-charger. During charging, you can view a range of charging information by browsing the menu structure.

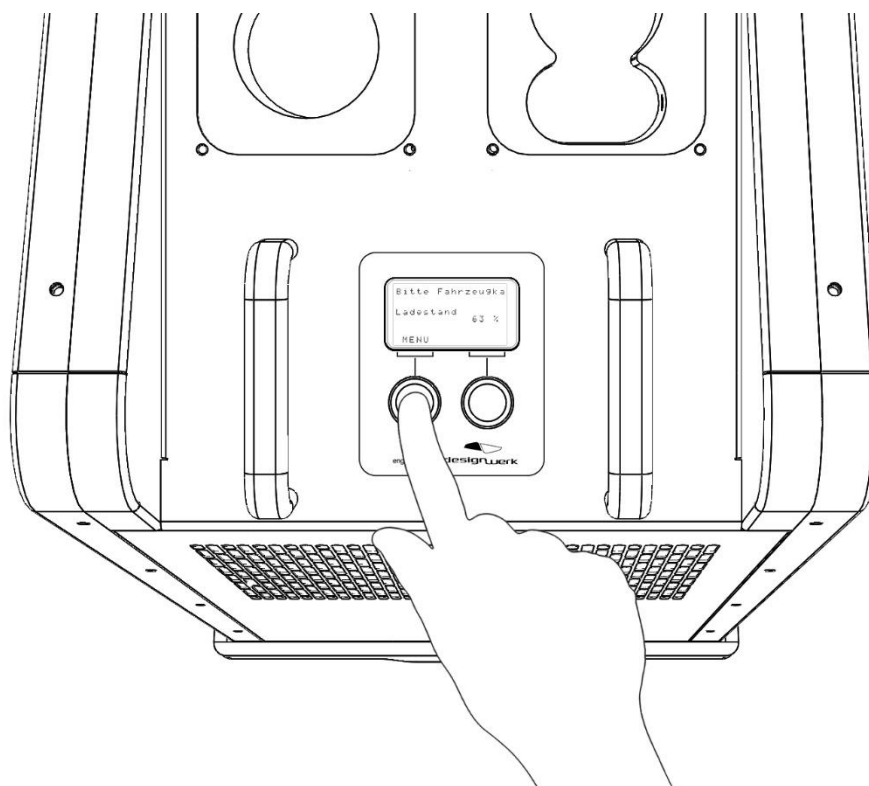

Document name

Technical documentation. Operation of the Mobile DC Fast-Charger



Author
V. Dettwiler, Designwerk GmbH

Revision
2.0

Date
29. June 2017

Page
23 / 28

6.4 Menu structure

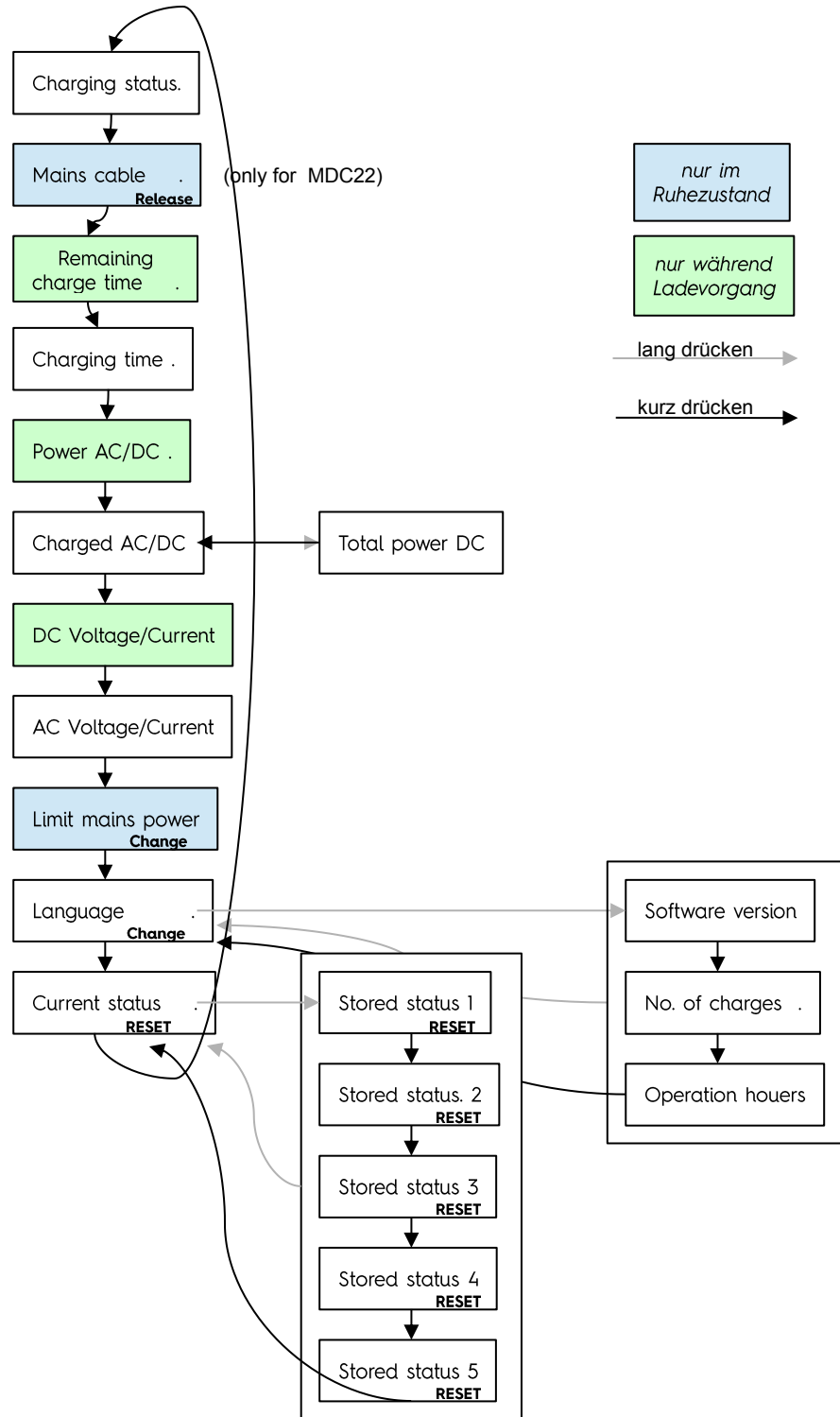

We reserve the right to make technical changes to the menu structure.

Document name Technical documentation. Operation of the Mobile DC Fast-Charger			
Author V. Dettwiler, Designwerk GmbH	Revision 2.0	Date 29. June 2017	Page 24 / 28

6.5 Ending the charging process

The charging process will end automatically once the battery is fully charged. Depending on the vehicle, you then simply need to pull the DC plug out of the vehicle or first unlock the charging port in the vehicle or using the remote key.

If you want to stop the charging process before it is completed, press the STOP button. You can now charge additional vehicles or stow away the device.

6.6 Storing the charger after use

The device's fan may continue to run after charging is stopped at full power. Despite this, you can still disconnect the device and stow it away, but be aware that the device may be hot.

To disconnect the device from the mains, first press the UNLOCK button. You can then pull out both ends of the AC cable. To stow the device, you just need to disconnect the DC cable from the device.

Follow the transportation and storage advice given in section 5.5 when stowing the device.

Document name			
Technical documentation. Operation of the Mobile DC Fast-Charger			
Author	Revision	Date	Page
V. Dettwiler, Designwerk GmbH	2.0	29. June 2017	25 / 28

7 Warranty

Designwerk GmbH provides a 24-month warranty from the date of purchase. This warranty covers demonstrable functional, material and construction faults. The warranty is valid across the European Union and EFTA states. It is a bring-in warranty.

7.1 Warranty claims

- Contact us before returning the product. We will then discuss with you what to do next.
- If the defect falls within the defects covered by the warranty, you will receive a repaired or new replacement device.

7.2 Warranty exclusions

The warranty is voided with immediate effect if the seal on the casing is damaged or missing through unauthorized opening. Designwerk GmbH assumes no liability for damage caused by incorrect or improper handling or use of the device.

Claims for liability cannot be asserted against Designwerk GmbH in the event of injury resulting from failure to observe general and product-specific safety information.

Designwerk GmbH accepts no liability for peripheral damage resulting from use of this device. If unsure about any aspect of using this product, seek clarification from our Support Team BEFORE using the product.

8 Additional notes

Designwerk GmbH reserves the right to make modifications in the interest of technical development. Furthermore, Designwerk GmbH offers no guarantee that all requirements, regulations and standards contained herein are free of the rights of third parties.

Document name			
Technical documentation. Operation of the Mobile DC Fast-Charger			
Author	Revision	Date	Page
V. Dettwiler, Designwerk GmbH	2.0	29. June 2017	26 / 28

9 Apendix

9.1 Error list

No.	Group	Area	Text	Fix	Permitted number
1	0	General	Charger error	Switch off device (remove all cables) and restart charging process	1x
2	0	General	Communication with charger error	Switch off device (remove all cables) and restart charging process	1x
3	0	General	Loss of mains voltage	Check presence of mains voltage on input side (fuses)	3x
4	0	General	Interlock error	Check the vehicle-side cable is connected correctly to the fast-charger and is locked	1x
5	0	General	Inadequate ventilation warning	Check the ventilation port and exhaust port to ensure they are not blocked and air can circulate	-
17	0	CHAdEMO	Battery overvoltage	Vehicle-side error. Switch vehicle off and back on again	1x
18	0	CHAdEMO	Battery undervoltage	Vehicle-side error. Switch vehicle off and back on again	1x
19	0	CHAdEMO	Power difference	Vehicle-side error. Switch vehicle off and back on again	1x
20	0	CHAdEMO	Excessive battery temperature	Pause charging then restart again after a short while	
21	0	CHAdEMO	Voltage difference	Vehicle-side error. Switch vehicle off and back on again	1x
22	0	CHAdEMO	Gear shifter position	Put shifter in 'P' position	-
23	0	CHAdEMO	Other vehicle error	Vehicle-side error. Switch vehicle off and back on again	1x
24	0	CHAdEMO	Battery incompatibility	Charger incompatible with vehicle	1x
25	1	CHAdEMO	Battery error on connection	Vehicle-side error. Switch vehicle off and back on again	1x
26	1	CHAdEMO	Communication error on connection	Vehicle-side error. Switch vehicle off and back on again	1x
27	1	CHAdEMO	Charge start error	Vehicle-side error. Switch vehicle off and back on again	1x
28	1	CHAdEMO	Voltage with insulation test	Vehicle-side error. Switch vehicle off and back on again	1x
29	1	CHAdEMO	Plug not locked	Vehicle-side error. Switch vehicle off and back on again	1x
30	1	CHAdEMO	Power draw too high	Vehicle-side error. Switch vehicle off and back on again	1x
31	1	CHAdEMO	No power drawn	Vehicle-side error. Switch vehicle off and back on again	1x
32	1	CHAdEMO	Charging communication error	Vehicle-side error. Switch vehicle off and back on again	1x
33	2	CHAdEMO	No voltage reduction	Error with terminating charging. If error reoccurs, contact the manufacturer	-
34	2	CHAdEMO	Insulation test error	Check vehicle-side charging cable for damage	1x
35	2	CHAdEMO	Insulation test warning	Check vehicle-side charging cable for damage	-
41	0	CCS	Internal communication error	Switch off device (remove all cables) and restart charging process	1x

Document name

Technical documentation. Operation of the Mobile DC Fast-Charger



 Author
 V. Dettwiler, Designwerk GmbH

 Revision
 2.0

 Date
 29. June 2017

 Page
 27 / 28

42	0	CCS	Excess charging plug temperature	Check the charging plug for damage. Plug must be inserted correctly	1x
43	0	CCS	Insulation test error	Check vehicle-side charging cable for damage	1x
44	0	CCS	Maximum pre-charge time exceeded	Can occur if the charger is exposed to very low temperatures	3x
49	1	CCS	High charging plug temperature	Check the charging plug for damage. Plug must be inserted correctly	-
50	1	CCS	Insulation test warning	Check vehicle-side charging cable for damage	-
57	2	CCS	Vehicle temperature limit	If it reoccurs, postpone charging	1x
58	2	CCS	Vehicle gear position	Put vehicle gear shifter in 'P' position	1x
59	2	CCS	Vehicle plug lock error	Check plug is inserted correctly	1x
60	2	CCS	Vehicle battery error		1x
61	2	CCS	Vehicle power deviation		1x
62	2	CCS	Vehicle voltage out of range		1x
63	2	CCS	Vehicle charging system incompatible		1x
78	1	Charger	Excess internal temperature		
81	2	Charger	Communications error		
82	2	Charger	Communications error		
83	2	Charger	Mains-side voltage outage		
84	2	Charger	DC voltage outside permissible range		
85	2	Charger	Excess input plug temperature		
105	5	Charger	Drop in performance		
106	5	Charger	Internal high temperature warning		
113	6	Charger	Communications error		
114	6	Charger	Communications error		
115	6	Charger	Communications error		
116	6	Charger	Communications error		
120	6	Charger	Input plug lock warning		
122	7	Charger	Mains voltage not permitted		
123	7	Charger	Mains frequency not permitted		

Document name			
Technical documentation. Operation of the Mobile DC Fast-Charger			
Author	Revision	Date	Page
V. Dettwiler, Designwerk GmbH	2.0	29. June 2017	28 / 28